

# Partition FIBRAN SW 125/75

Partition drywall EI90/60 - thickness 125 mm

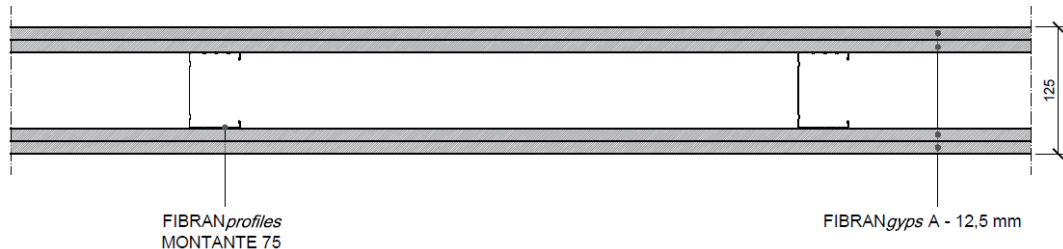

## COMPONENTS

### Plasterboards

2 layers of **FIBRANGyps A** both side, thickness **12,5 mm**, CE marked– **type A** according to EN 520, classified **A+** according to EN ISO 16000-09, fire reaction **A2-s1,d0** according to EN 13501-1, weight 9,2 kg/m<sup>2</sup>, water vapor resistance factor  $\mu=10$ , thermal conductivity  $\lambda=0,25$  W/m K and specific heat  $cp=1,03$  kJ/kg K according to EN 10456

### Metal frame thickness 0,6 mm conform to EN 14195

Channels **FIBRANprofiles GUIDA 75** mechanically fixed to the floor and ceiling using fixing nails at a maximum spacing of 500 mm;

Studs **FIBRANprofiles MONTANTE 75**, max axial spacing every 600 mm, slotted to allow passage of the installations

### Screws

Self-drilling screws **FIBRANGyps SCREW 3,5 x 25** and **3,5 x 35 mm** with resistance in salt spray test not less than 72 hours, fixed max 250 mm each

### Adhesive tape and joint filler

Closed cell polyethylene foam adhesive tape **FIBRANGyps** to be applied on the entire perimeter of the metal structure, to eliminate the possible acoustic bridges due to the transmission of noise through the building structures.

Treatment of the joints between plasterboards and head of screws with **FIBRANGyps JF**, CE marked 3B according to EN 13963, and reinforcing tape **FIBRANGyps TAPE** according to the level quality Q2 UNI 11424 (Eurogypsum)

# Partition FIBRAN SW 125/75

## Technical features

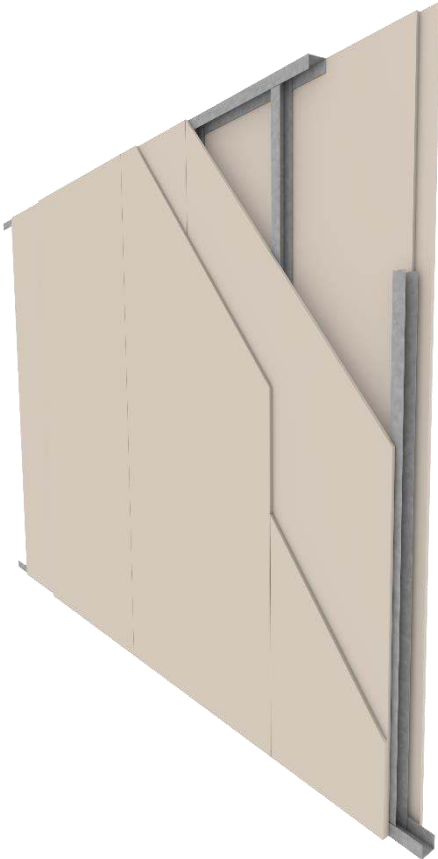

### Fire rating

Fire rating: **EI 90** until 4 m, **EI 60** for higher heights (Classification Report LAPI 168/C/14-243FR according to EN 1364-1)

Max height: 15,90 m with technical dossier

### Mechanical performance

**FIBRANprofiles** channels and studs DIN 750 mm, max axial spacing every 600 mm, thickness 6/10 mm conform to EN 14195.

Profiles must be designed according to local regulation and specific application.

In case of walls longer than 15 meters, an expansion joint must be made every 10 meters or at structural joints

### Finishing

According to quality level required (Eurogypsum). Use FIBRANGYPS JF READY MIX for level Q4

### Sustainability

FIBRANGYPS plasterboards are classified A+, the best one according to EN ISO 16000-09, with regards to the emission of formaldehyde, acetaldehyde and other substances

# Partition FIBRAN SW 125/75

## Construction details

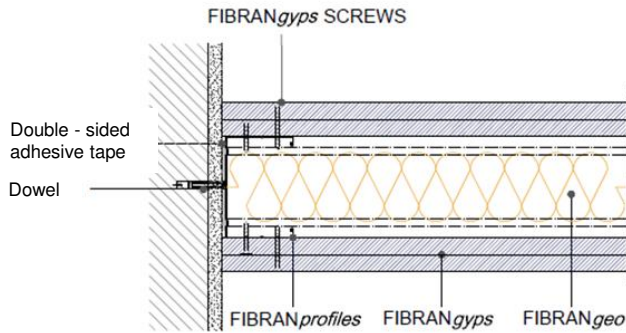

Detail. 1 **WALL CONNECTION**

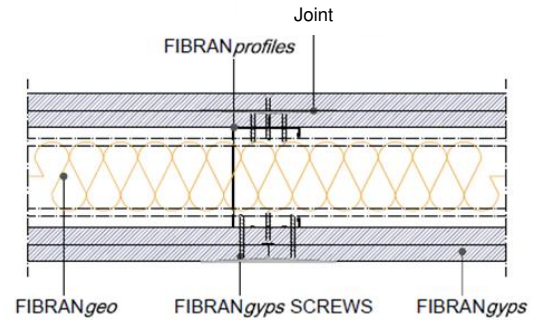

Detail. 2 **JOINT**

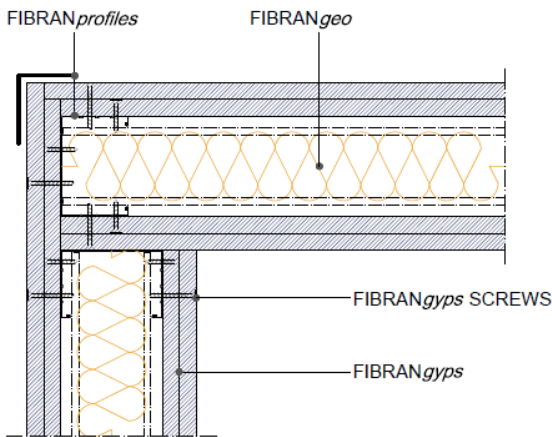

Detail. 3 **CORNER FITTING**

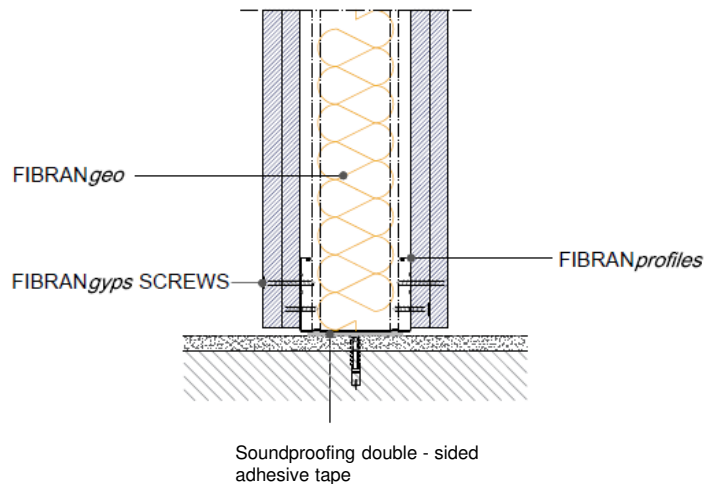

Detail. 4 **FLOOR CONNECTION**

# Partition FIBRAN SW 125/75 Construction details

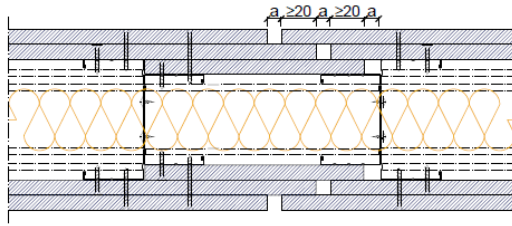

Detail. 5 **EXPANSION JOINT**

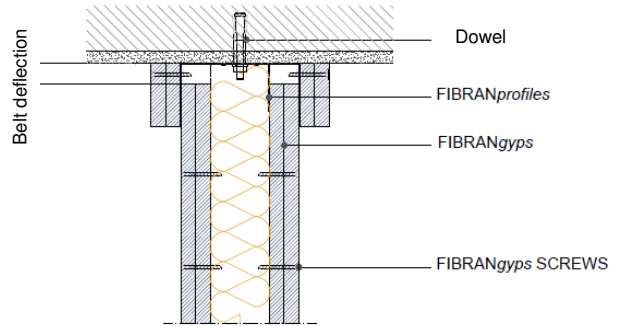

Detail. 6 **DESOLIDARIZZAZIONE FLOOR - WALL**

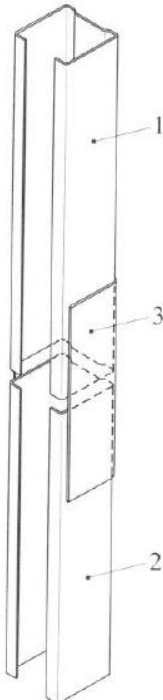

Note: indicative drawings

**LEGEND**





- 1. stud
- 2. stud
- 3. stiffening element made with a channel of the same width as the stud; lenght at least 10 times the width

Detail. 7 **JOINT BETWEEN PROFILES**

# Partition FIBRAN SW 125/75

## Quantities of material

### Indicative quantities for square meter of partition

		quantity/m <sup>2</sup>		quantity/m <sup>2</sup>	
		centre 600 mm		centre 400 mm	
Description	UM				
FIBRANgy <sup>ps</sup>	m <sup>2</sup>	4,2	4,2	4,2	4,2
FIBRAN <i>profiles</i> studs	m	2	4	2,6	5,2
FIBRAN <i>profiles</i> channels	m	0,7	0,7	0,7	0,7
Joint filler FIBRANgy <sup>ps</sup> <b>JF</b>	kg	0,7	0,7	0,7	0,7
Adhesive tape FIBRAN <i>profiles</i>	m	1	1	1	1
FIBRANgy <sup>ps</sup> <b>TAPE</b>	m	1,67	1,67	1,67	1,67
FIBRANgy <sup>ps</sup> <b>SCREW</b> 25mm	pz	20	20	25	25
FIBRANgy <sup>ps</sup> <b>SCREW</b> 35mm	pz	25	25	30	30